

# Pneufit® C composite and Pneufit M fittings

Inch

Ø 1/8" to 1/2" O/D tube

Ready to use.

Over 1,000 composite push-in pneumatic fittings.

Releasable stainless-steel grab-ring to grip nylon or polyurethane tube (85 or 95 durometer).

Nickel plated brass components.

Pre applied thread sealant on all taper threads and recessed captive O-ring on parallel threads.

Internal and external hexagons on straight fittings.

Immediate quality sealing using silicone free U-packing.

Mounting holes on all union fittings.

Introducing Miniature Pneufit M an ultra compact alternative where space is at a premium.

## Technical data

Medium

Compressed air

Operating pressure

29.5" Hg vacuum up to 150 psi

Temperature

32°F to 140°F

## Materials

Body: PBT

Seals: NBR (silicone free) u-packaging and O-rings

Threaded bodies: nickel plated brass

Release sleeve and backing ring: POM

Grab-ring: stainless steel

Collar: nickel plated brass

Thread sealant: threebond 2350B

## Tube sizes

Standard sizes: 5/32", 3/16", 1/4", 5/16", 3/8" and 1/2"

Miniature sizes: 1/8", 1/4", 5/32"

## Thread sizes

Standard sizes: 10-32 UNF, 1/8", 1/4", 3/8 and 1/2" NPT and ISO R

Miniature sizes: 10-32 UNF, 1/16" and 1/8" NPT

## Tube types

Nylon 11 or 12

Polyurethane 85 or 95 durometer



- 1 Impact resistant PBT body in black for Pneufit® C and light gray for Pneufit® M.
- 2 Release buttons are red for metric, grey for inch, and light grey oval for Pneufit® M.
- 3 Stainless steel grab ring with special design to retain softer tube and provide easy releasability.
- 4 Silicon free U-packing provides leak tight tube seal under side loading.
- 5 Stem seal provides leak tight 360° swivel connection.
- 6 Nickel plated brass threads and notches on hex to signify NPT.
- 7 Pre-applied thread sealant on tapered threads and recessed captive O-ring on parallel threads.

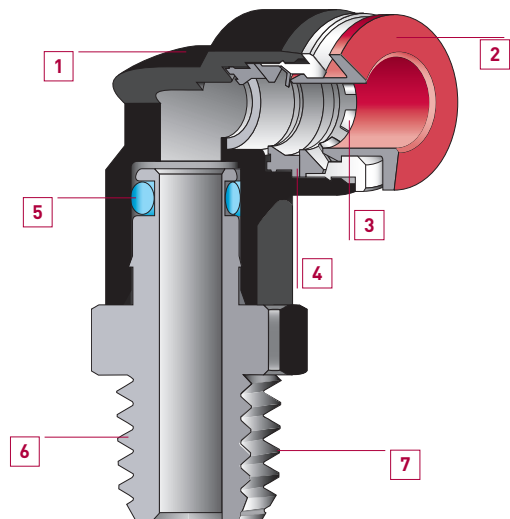

## Method of assembly

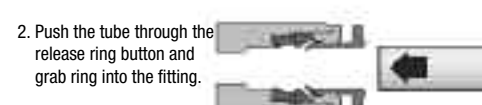
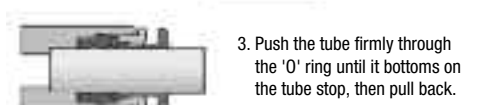
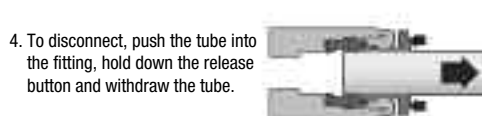
1. Ensure that the end tube is cut square and is free from burrs. 
2. Push the tube through the release ring button and grab ring into the fitting. 
3. Push the tube firmly through the 'O' ring until it bottoms on the tube stop, then pull back. 
4. To disconnect, push the tube into the fitting, hold down the release button and withdraw the tube. 

# Pneufit® C composite and Pneufit M fittings

Inch

Ø 1/8" to 1/2" O/D tube

## Straight adapter (external + internal hex)



O/D tube	Thread	Part number
5/32"	10-32 UNF	C24250210
5/32"	1/8" NPT	C24250218
5/32"	1/4" NPT	C24250228
5/32"	3/8" NPT	C24250238
5/32"	1/8" R	C01250418
5/32"	1/4" R	C01250428
5/32"	3/8" R	C01250438
3/16"	10-32 UNF	C24250310
3/16"	1/8" NPT	C24250318
3/16"	1/4" NPT	C24250328
3/16"	3/8" NPT	C24250338
1/4"	10-32 UNF	C24250410
1/4"	1/8" NPT	C24250418
1/4"	1/4" NPT	C24250428
1/4"	3/8" NPT	C24250438
1/4"	1/2" NPT	C24250448
1/4"	1/8" R	C21250418
1/4"	1/4" R	C21250428
1/4"	3/8" R	C21250438
5/16"	1/8" NPT	C24250518
5/16"	1/4" NPT	C24250528
5/16"	3/8" NPT	C24250538
5/16"	1/2" NPT	C24250548
5/16"	1/8" R	C01250818
5/16"	1/4" R	C01250828
5/16"	3/8" R	C01250838
5/16"	1/2" R	C01250848
3/8"	1/8" NPT	C24250618
3/8"	1/4" NPT	C24250628
3/8"	3/8" NPT	C24250638
3/8"	1/2" NPT	C24250648
3/8"	1/8" R	C21250618
3/8"	1/4" R	C21250628
3/8"	3/8" R	C21250638
3/8"	1/2" R	C21250648
1/2"	1/8" NPT	C24250718
1/2"	1/4" NPT	C24250728
1/2"	3/8" NPT	C24250738
1/2"	1/2" NPT	C24250748
1/2"	1/4" R	C21250728
1/2"	3/8" R	C21250738
1/2"	1/2" R	C21250748

## Straight adapter (internal hex only)



O/D tube	Thread	Part number
5/32"	10-32 UNF	C242A0210
5/32"	1/8" NPT	C242A0218
5/32"	1/4" NPT	C242A0228
5/32"	1/8" R	C012A0418
5/32"	1/4" R	C012A0428
5/32"	3/8" R	C012A0438
3/16"	10-32 UNF	C242A0310
3/16"	1/8" NPT	C242A0318
3/16"	1/4" NPT	C242A0328
1/4"	10-32 UNF	C242A0410
1/4"	1/8" NPT	C242A0418
1/4"	1/4" NPT	C242A0428
1/4"	1/8" R	C212A0418
1/4"	1/4" R	C212A0428
5/16"	1/8" NPT	C242A0518
5/16"	1/4" NPT	C242A0528
5/16"	3/8" NPT	C242A0538
5/16"	1/8" R	C012A0818
5/16"	1/4" R	C012A0828
5/16"	3/8" R	C012A0838
3/8"	1/8" NPT	C242A0618
3/8"	1/4" NPT	C242A0628
3/8"	3/8" NPT	C242A0638
3/8"	1/2" NPT	C242A0648
3/8"	1/4" R	C212A0628
3/8"	3/8" R	C212A0638
3/8"	1/2" R	C212A0648
1/2"	1/4" NPT	C242A0728
1/2"	3/8" NPT	C242A0738
1/2"	1/2" NPT	C242A0748

## Straight adapter (female thread)



O/D tube	Thread	Part number
5/32"	1/8" NPT	C24260218
5/32"	1/4" NPT	C24260228
5/32"	1/8" R	C02260418
5/32"	1/4" R	C02260428
3/16"	1/8" NPT	C24260318
3/16"	1/4" NPT	C24260328
1/4"	1/8" NPT	C24260418
1/4"	1/4" NPT	C24260428
1/4"	3/8" NPT	C24260438
1/4"	1/8" R	C21260418
1/4"	1/4" R	C21260428
5/16"	1/8" NPT	C24260518
5/16"	1/4" NPT	C24260528
5/16"	3/8" NPT	C24260538
5/16"	1/2" NPT	C24260548
5/16"	1/8" R	C02260818
5/16"	1/4" R	C02260828
3/8"	1/8" NPT	C24260618
3/8"	1/4" NPT	C24260628
3/8"	3/8" NPT	C24260638
3/8"	1/2" NPT	C24260648
3/8"	1/4" R	C21260628
3/8"	3/8" R	C21260638
1/2"	1/4" NPT	C24260728
1/2"	3/8" NPT	C24260738

# Pneufit C push-in fittings

Inch

Ø 1/8" to 1/2" O/D tube



## Female bulkhead

O/D tube	Thread	Part number
5/32"	1/8" NPT	C24320218
3/16"	1/8" NPT	C24320318
3/16"	1/4" NPT	C24320328
1/4"	1/8" NPT	C24320418
1/4"	1/4" NPT	C24320428
5/16"	1/8" NPT	C24320518
5/16"	1/4" NPT	C24320528
5/16"	3/8" NPT	C24320538
3/8"	1/4" NPT	C24320628
3/8"	3/8" NPT	C24320638
1/2"	1/4" NPT	C24320728
1/2"	3/8" NPT	C24320738
1/2"	1/2" NPT	C24320748



## 90° Swivel elbow adapter (extended)

O/D tube	Thread	Part number
5/32"	10-32 UNF	C24540210
5/32"	1/8" NPT	C24540218
5/32"	1/4" NPT	C24540228
5/32"	1/8" R	C01540418
5/32"	1/4" R	C01540428
5/32"	3/8" R	C01540438
3/16"	1/8" NPT	C24540318
3/16"	1/4" NPT	C24540328
3/16"	3/8" NPT	C24540338
1/4"	10-32 UNF	C24540410
1/4"	1/8" NPT	C24540418
1/4"	1/4" NPT	C24540428
1/4"	3/8" NPT	C24540438
1/4"	1/8" R	C21540418
1/4"	1/4" R	C21540428
5/16"	1/8" NPT	C24540518
5/16"	1/4" NPT	C24540528
5/16"	3/8" NPT	C24540538
5/16"	1/8" R	C01540818
5/16"	1/4" R	C01540828
5/16"	3/8" R	C01540838
3/8"	1/8" NPT	C24540618
3/8"	1/4" NPT	C24540628
3/8"	3/8" NPT	C24540638
3/8"	1/2" NPT	C24540648
3/8"	1/4" R	C21540628
3/8"	3/8" R	C21540638
1/2"	1/4" NPT	C24540728
1/2"	3/8" NPT	C24540738
1/2"	1/2" NPT	C24540748



## 90° Swivel elbow

O/D tube	Thread	Part number
5/32"	10-32 UNF	C24470210
5/32"	1/8" NPT	C24470218
5/32"	1/4" NPT	C24470228
5/32"	1/8" R	C01470418
5/32"	1/4" R	C01470428
5/32"	3/8" R	C01470438
3/16"	10-32 UNF	C24470310
3/16"	1/8" NPT	C24470318
3/16"	1/4" NPT	C24470328
3/16"	3/8" NPT	C24470338
1/4"	10-32 UNF	C24470410
1/4"	1/8" NPT	C24470418
1/4"	1/4" NPT	C24470428
1/4"	3/8" NPT	C24470438
1/4"	1/8" R	C21470418
1/4"	1/4" R	C21470428
1/4"	3/8" R	C21470438
5/16"	1/8" NPT	C24470518
5/16"	1/4" NPT	C24470528
5/16"	3/8" NPT	C24470538
5/16"	1/2" NPT	C24470548
5/16"	1/8" R	C01470818
5/16"	1/4" R	C01470828
5/16"	3/8" R	C01470838
3/8"	1/8" NPT	C24470618
3/8"	1/4" NPT	C24470628
3/8"	3/8" NPT	C24470638
3/8"	1/2" NPT	C24470648
3/8"	1/8" R	C21470618
3/8"	1/4" R	C21470628
3/8"	3/8" R	C21470638
3/8"	1/2" R	C21470648
1/2"	1/4" NPT	C24470728
1/2"	3/8" NPT	C24470738
1/2"	1/2" NPT	C24470748
1/2"	1/4" R	C21470728
1/2"	3/8" R	C21470738
1/2"	1/2" R	C21470748



## 90° Swivel elbow adapter (female)

O/D tube	Thread	Part number
5/32"	10-32 UNF	C24480210
5/32"	1/8" NPT	C24480218
5/32"	1/4" NPT	C24480228
5/32"	1/8" R	C01480418
3/16"	10-32 UNF	C24480310
3/16"	1/8" NPT	C24480318
3/16"	1/4" NPT	C24480328
1/4"	10-32 UNF	C24480410
1/4"	1/8" NPT	C24480418
1/4"	1/4" NPT	C24480428
1/4"	3/8" NPT	C24480438
5/16"	1/8" NPT	C24480518
5/16"	1/4" NPT	C24480528
5/16"	3/8" NPT	C24480538
5/16"	1/8" R	C01480818
5/16"	1/4" R	C01480828
3/8"	1/4" NPT	C24480628
3/8"	3/8" NPT	C24480628
3/8"	1/2" NPT	C24480648
1/2"	3/8" NPT	C24480738
1/2"	1/2" NPT	C24480748

# Pneufit C push-in fittings

Inch

Ø 1/8" to 1/2" O/D tube

Swivel Y adapter

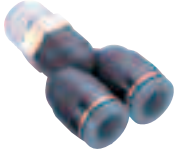

O/D tube	Thread	Part number
5/32"	10-32 UNF	C24880210
5/32"	1/8" NPT	C24880218
5/32"	1/4" NPT	C24880228
5/32"	1/8" R	C01880418
5/32"	1/4" R	C01880428
5/32"	3/8" R	C01880438
3/16"	10-32 UNF	C24880310
3/16"	1/8" NPT	C24880318
3/16"	1/4" NPT	C24880328
3/16"	3/8" NPT	C24880338
1/4"	10-32 UNF	C24880410
1/4"	1/8" NPT	C24880418
1/4"	1/4" NPT	C24880428
1/4"	3/8" NPT	C24880438
1/4"	1/8" R	C21880418
1/4"	1/4" R	C21880428
1/4"	3/8" R	C21880438
5/16"	1/8" NPT	C24880518
5/16"	1/4" NPT	C24880528
5/16"	3/8" NPT	C24880538
5/16"	1/2" NPT	C24880548
5/16"	1/8" R	C01880818
5/16"	1/4" R	C01880828
5/16"	3/8" R	C01880838
3/8"	1/8" NPT	C24880618
3/8"	1/4" NPT	C24880628
3/8"	3/8" NPT	C24880638
3/8"	1/2" NPT	C24880648
3/8"	1/4" R	C21880628
3/8"	3/8" R	C21880638
3/8"	1/2" R	C21880648
1/2"	1/4" NPT	C24880728
1/2"	3/8" NPT	C24880738
1/2"	1/2" NPT	C24880748
1/2"	1/4" R	C21880728
1/2"	3/8" R	C21880738
1/2"	1/2" R	C21880748

Swivel tee adapter



O/D tube	Thread	Part number
5/32"	10-32 UNF	C24670210
5/32"	1/8" NPT	C24670218
5/32"	1/4" NPT	C24670228
5/32"	1/8" R	C01670418
5/32"	1/4" R	C01670428
5/32"	3/8" R	C01670438
3/16"	10-32 UNF	C24670310
3/16"	1/8" NPT	C24670318
3/16"	1/4" NPT	C24670328
3/16"	3/8" NPT	C24670338
1/4"	10-32 UNF	C24670410
1/4"	1/8" NPT	C24670418
1/4"	1/4" NPT	C24670428
1/4"	3/8" NPT	C24670438
1/4"	1/8" R	C21670418
1/4"	1/4" R	C21670428
1/4"	3/8" R	C21670438
5/16"	1/8" NPT	C24670518
5/16"	1/4" NPT	C24670528
5/16"	3/8" NPT	C24670538
5/16"	1/2" NPT	C24670548
5/16"	1/8" R	C01670818
5/16"	1/4" R	C01670828
5/16"	3/8" R	C01670838
3/8"	1/8" NPT	C24670618
3/8"	1/4" NPT	C24670628
3/8"	3/8" NPT	C24670638
3/8"	1/2" NPT	C24670648
3/8"	1/8" R	C21670618
3/8"	1/4" R	C21670628
3/8"	3/8" R	C21670638
3/8"	1/2" R	C21670648
1/2"	1/4" NPT	C24670728
1/2"	3/8" NPT	C24670738
1/2"	1/2" NPT	C24670748
1/2"	1/4" R	C21670728
1/2"	3/8" R	C21670738
1/2"	1/2" R	C21670748

# Pneufit C push-in fittings

Inch

Ø 1/8" to 1/2" O/D tube



Swivel side tee adapter

O/D tube	Thread	Part number
5/32"	10-32 UNF	C24680210
5/32"	1/8" NPT	C24680218
5/32"	1/4" NPT	C24680228
5/32"	1/8" R	C01680418
5/32"	1/4" R	C01680428
5/32"	3/8" R	C01680438
3/16"	10-32 UNF	C24680310
3/16"	1/8" NPT	C24680318
3/16"	1/4" NPT	C24680328
3/16"	3/8" NPT	C24680338
1/4"	10-32 UNF	C24680410
1/4"	1/8" NPT	C24680418
1/4"	1/4" NPT	C24680428
1/4"	3/8" NPT	C24680438
1/4"	1/8" R	C21680418
1/4"	1/4" R	C21680428
1/4"	3/8" R	C21680438
5/16"	1/8" NPT	C24680518
5/16"	1/4" NPT	C24680528
5/16"	3/8" NPT	C24680538
5/16"	1/2" NPT	C24680548
5/16"	1/8" R	C01680818
5/16"	1/4" R	C01680828
5/16"	3/8" R	C01680838
3/8"	1/8" NPT	C24680618
3/8"	1/4" NPT	C24680628
3/8"	3/8" NPT	C24680638
3/8"	1/2" NPT	C24680648
3/8"	1/4" R	C21680628
3/8"	3/8" R	C21680638
3/8"	1/2" R	C21680648
1/2"	1/4" NPT	C24680728
1/2"	3/8" NPT	C24680738
1/2"	1/2" NPT	C24680748
1/2"	1/4" R	C21680728
1/2"	3/8" R	C21680738
1/2"	1/2" R	C21680748



Banjo

O/D tube	Thread	Part number
5/32"	10-32 UNF	C2R510210
5/32"	1/8" NPT	C2R510218
1/4"	10-32 UNF	C2R510410
1/4"	1/8" NPT	C2R510418
1/4"	1/4" NPT	C2R510428
5/16"	1/8" NPT	C2R510518
5/16"	1/4" NPT	C2R510528
3/8"	1/4" NPT	C2R510628
3/8"	3/8" NPT	C2R510638
3/8"	1/2" NPT	C2R510648
1/2"	3/8" NPT	C2R510738
1/2"	1/2" NPT	C2R510748



Banjo with top port

O/D tube	Thread	Part number
5/32"	10-32 UNF	C2D510210
5/32"	1/8" NPT	C2E510218
1/4"	10-32 UNF	C2D510410
1/4"	1/8" NPT	C2E510418
1/4"	1/4" NPT	C2F510428
5/16"	1/8" NPT	C2E510518
5/16"	1/4" NPT	C2F510528
3/8"	1/4" NPT	C2F510628
3/8"	3/8" NPT	C2G510638
1/2"	3/8" NPT	C2G510738



Banjo flow control (regulating out)

O/D tube	Thread	Part number
5/32"	10-32 UNF	C2VA00210
5/32"	1/8" NPT	C2VA00218
5/32"	M5	C0K510405
5/32"	1/8"R	C0TA00418
5/32"	1/4"R	C0TA00428
3/16"	10-32 UNF	C2VA00310
3/16"	1/8" NPT	C2VA00318
3/16"	1/4" NPT	C2VA00328
3/16"	3/8" NPT	C2VA00338
1/4"	10-32 UNF	C2VA00410
1/4"	1/8" NPT	C2VA00418
1/4"	1/4" NPT	C2VA00428
1/4"	3/8" NPT	C2VA00438
1/4"	M5	C2VA00405
1/4"	1/8"R	C2TA00418
1/4"	1/4"R	C2TA00428
5/16"	1/8" NPT	C2VA00518
5/16"	1/4" NPT	C2VA00528
5/16"	3/8" NPT	C2VA00538
5/16"	1/2" NPT	C2VA00548
5/16"	1/8"R	C0TA00818
5/16"	1/4"R	C0TA00828
5/16"	3/8"R	C0TA00838
3/8"	1/4" NPT	C2VA00628
3/8"	3/8" NPT	C2VA00638
3/8"	1/2" NPT	C2VA00648
3/8"	1/4"R	C2TA00628
3/8"	3/8"R	C2TA00638
1/2"	3/8" NPT	C2VA00738
1/2"	1/2" NPT	C2VA00748

Swivel tee adapter



O/D tube	Thread	Part number
5/32"	1/8" NPT	C246C0218
3/16"	1/8" NPT	C246C0318
3/16"	1/4" NPT	C246C0328
1/4"	1/8" NPT	C246C0418
1/4"	1/4" NPT	C246C0428
5/16"	1/8" NPT	C246C0518
5/16"	1/4" NPT	C246C0528
5/16"	3/8" NPT	C246C0538
3/8"	1/4" NPT	C246C0628
3/8"	3/8" NPT	C246C0638
1/2"	3/8" NPT	C246C0738
1/2"	1/2" NPT	C246C0748

# Pneufit C push-in fittings

Inch

Ø 1/8" to 1/2" O/D tube



In line flow control

O/D tube	Part number
5/32"	C20GE0200
3/16"	C20GE0300
1/4"	C20GE0400
5/16"	C20GE0500
3/8"	C20GE0600
1/2"	C20GE0700



Plug

O/D tube	Part number
5/32"	C00040400
3/16"	C20040300
1/4"	C20040400
5/16"	C00040800
3/8"	C20040600
1/2"	C20040700



Straight union

O/D tube	Part number
5/32"	C20200200
3/16"	C20200300
1/4"	C20200400
5/16"	C20200500
3/8"	C20200600
1/2"	C20200700

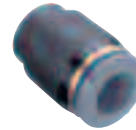

Cap

O/D tube	Part number
5/32"	C20120200
3/16"	C20120300
1/4"	C20120400
5/16"	C20120500
3/8"	C20120600
1/2"	C20120700

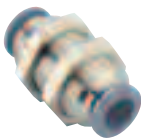

Bulkhead union

O/D tube	Part number
5/32"	C20290200
3/16"	C20290300
1/4"	C20290400
5/16"	C20290500
3/8"	C20290600
1/2"	C20290700

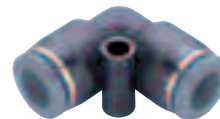

Union elbow

O/D tube	Part number
5/32"	C20400200
3/16"	C20400300
1/4"	C20400400
5/16"	C20400500
3/8"	C20400600
1/2"	C20400700



Stem union

O/D tube	Part number
5/32"	C20220200
3/16"	C20220300
1/4"	C20220400
5/16"	C20220500
3/8"	C20220600
1/2"	C20220700



Stem elbow

O/D tube	Part number
5/32"	C20430200
3/16"	C20430300
1/4"	C20430400
5/16"	C20430500
3/8"	C20430600
1/2"	C20430700

# Pneufit C push-in fittings

Inch

Ø 1/8" to 1/2" O/D tube



Union tee

O/D tube	Part number
5/32"	C20600200
3/16"	C20600300
1/4"	C20600400
5/16"	C20600500
3/8"	C20600600
1/2"	C20600700



Stem Y

O/D tube	Part number
5/32"	C20840202
3/16"	C20840300
1/4"	C20840404
5/16"	C20840505
3/8"	C20840600
1/2"	C20840700



Stem tee

O/D tube	Part number
5/32"	C20630200
3/16"	C20630300
1/4"	C20630400
5/16"	C20630500
3/8"	C20630600
1/2"	C20630700



Union cross

O/D tube	Part number
5/32"	C20900200
3/16"	C20900300
1/4"	C20900400
5/16"	C20900500
3/8"	C20900600
1/2"	C20900700



Stem side tee

O/D tube	Part number
5/32"	C20640200
3/16"	C20640300
1/4"	C20640400
5/16"	C20640500
3/8"	C20640600
1/2"	C20640700



Straight union (unequal)

O/D tube	Part number
3/16" - 5/32"	C20200302
1/4" - 5/32"	C20200402
1/4" - 3/16"	C20200403
5/16" - 1/4"	C20200504
3/8" - 1/4"	C20200604
3/8" - 5/16"	C20200605
1/2" - 3/8"	C20200706



Union Y

O/D tube	Part number
5/32"	C20820200
3/16"	C20820300
1/4"	C20820400
5/16"	C20820500
3/8"	C20820600
1/2"	C20820700



Stem Reducer (stem/tube)

O/D tube	Part number
1/4" - 5/32"	C20230402
5/16" - 1/4"	C20230504
3/8" - 1/4"	C20230604
3/8" - 5/16"	C20230605
1/2" - 1/4"	C20230704
1/2" - 3/8"	C20230706

# Pneufit C push-in fittings

Inch

Ø 1/8" to 1/2" O/D tube



Stem Union (unequal)

O/D tube	Part number
3/16"-5/32"	C20220302
1/4"-5/32"	C20220402
1/4"-3/16"	C20220403
5/16"-1/4"	C20220504
3/8"-1/4"	C20220604
3/8"-5/16"	C20220605
1/2"-3/8"	C20220706



Stem Side Tee (unequal)

O/D tube	Part number
1/4"-5/32"	C20640402
5/16"-1/4"	C20640504
3/8"-1/4"	C20640604
1/2"-1/4"	C20640605



Union Tee (unequal)

O/D tube	Part number
1/4"-5/32"	C206A0402
5/16"-1/4"	C206A0504
3/8"-1/4"	C206A0604
3/8"-5/16"	C206A0605
1/2"-1/4"	C206A0704
1/2"-3/8"	C206A0706



Union Y (unequal)

O/D tube	Part number
3/16"-5/32"	C20820302
1/4"-5/32"	C20820402
1/4"-3/16"	C20820403
5/16"-1/4"	C20820504
3/8"-1/4"	C20820604
3/8"-5/16"	C20820605
1/2"-3/8"	C20820706



Stem Tee (unequal)

O/D tube	Part number
1/4"-5/32"	C20630402
5/16"-1/4"	C20630504
3/8"-1/4"	C20630604
3/8"-5/16"	C20630605



Stem Y (unequal)

O/D tube	Part number
1/4"-5/32"	C20840402
5/16"-1/4"	C20840504
3/8"-1/4"	C20840604
3/8"-5/16"	C20840605

# Pneufit M miniature fittings

Inch

Ø 1/8" to 1/2" O/D tube

## Straight adapter (external + internal hex)



O/D tube	Thread	Part number
1/8"	M3	M22250103
1/8"	M5	M22250105
1/8"	M6	M22250106
1/8"	10-32 UNF	M24250110
1/8"	1/16" NPT	M24250116
1/8"	1/8" NPT	M24250118
1/8"	1/8" R	M21250118
1/8"	1/4" NPT	M24250128
5/32"	M3	M02250403
5/32"	M5	M02250405
5/32"	M6	M02250406
5/32"	10-32 UNF	M24250210
5/32"	1/16" NPT	M24250216
5/32"	1/8" NPT	M24250218
5/32"	1/8" R	M01250418
1/4"	M5	M22250405
1/4"	M6	M22250406
1/4"	10-32 UNF	M24250410
1/4"	1/16" NPT	M24250416
1/4"	1/8" NPT	M24250418
1/4"	1/8" R	M21250418

## 90° Swivel Elbow Adapter



O/D tube	Thread	Part number
1/8"	M3	M22470103
1/8"	M5	M22470105
1/8"	M6	M22470106
1/8"	10-32 UNF	M24470110
1/8"	1/16" NPT	M24470116
1/8"	1/8" NPT	M24470118
1/8"	1/4" NPT	M24470128
5/32"	M3	M02470403
5/32"	M5	M02470405
5/32"	M6	M02470406
5/32"	10-32 UNF	M24470210
5/32"	1/16" NPT	M24470216
5/32"	1/8" NPT	M24470218
5/32"	1/8" R	M01470418
1/4"	M6	M22470406
1/4"	10-32 UNF	M24470410
1/4"	1/16" NPT	M24470416
1/4"	1/8" NPT	M24470418

## Straight adapter (internal hex only)



O/D tube	Thread	Part number
1/8"	M3	M222A0103
1/8"	M5	M222A0105
1/8"	M6	M222A0106
1/8"	10-32 UNF	M242A0110
1/8"	1/16" NPT	M242A0116
1/8"	1/8" NPT	M242A0118
5/32"	M3	M022A0403
5/32"	M5	M022A0405
5/32"	M6	M022A0406
5/32"	10-32 UNF	M242A0210
5/32"	1/16" NPT	M242A0216
5/32"	1/8" NPT	M242A0218
1/4"	M5	M242A0405
1/4"	M6	M242A0406
1/4"	10-32 UNF	M242A0410
1/4"	1/16" NPT	M242A0416
1/4"	1/8" NPT	M242A0418



## Swivel Tee Adapter

O/D tube	Thread	Part number
1/8"	M3	M22670103
1/8"	M5	M22670105
1/8"	M6	M22680106
1/8"	10-32 UNF	M24670110
1/8"	1/16" NPT	M24670116
1/8"	1/8" NPT	M24670118
5/32"	M3	M02670403
5/32"	M5	M02670405
5/32"	M6	M02670406
5/32"	10-32 UNF	M24670210
5/32"	1/16" NPT	M24670216
5/32"	1/8" NPT	M24670218
5/32"	1/8" R	M01670418
1/4"	M5	M22670405
1/4"	M6	M22670406
1/4"	10-32 UNF	M24670410
1/4"	1/16" NPT	M24670416
1/4"	1/8" NPT	M24670418
1/4"	1/8" R	M21670418

## Straight adapter (female thread)



O/D tube	Thread	Part number
1/8"	M3	M22260103
1/8"	M5	M22260105
1/8"	10-32 UNF	M24260110
1/8"	1/16" NPT	M24260116
1/8"	1/8" NPT	M24260118
1/8"	1/4" NPT	M24260128
5/32"	M3	M22260103
5/32"	M5	M22260105
5/32"	10-32 UNF	M24260210
5/32"	1/16" NPT	M24260216

# Pneufit M miniature fittings

Inch

Ø 1/8" to 1/2" O/D tube

## Swivel Side Tee Adapter



O/D tube	Thread	Part number
1/8"	M3	M24680103
1/8"	M5	M22680105
1/8"	M6	M22680106
1/8"	10-32 UNF	M24680110
1/8"	1/16" NPT	M24680116
1/8"	1/8" NPT	M24680118
5/32"	M3	M02680403
5/32"	M5	M02680405
5/32"	M6	M22680106
5/32"	10-32 UNF	M24680210
5/32"	1/16" NPT	M24680216
5/32"	1/8" NPT	M24680218
5/32"	1/8" R	M01680418
1/4"	M5	M22680405
1/4"	M6	M22680406
1/4"	10-32 UNF	M24680410
1/4"	1/16" NPT	M24680416
1/4"	1/8" NPT	M24680418
1/4"	1/8" R	M21680418

## Straight Union (unequal)



O/D tube	Part number
5/32"-1/8"	M20200201
1/4"-1/8"	M20200401
1/4"-5/32"	M20200402

## Stem Reducer (stem/tube)



O/D tube	Part number
5/32" to 1/8"	C20230201
1/4" to 1/8"	C20230401

## Straight Union



O/D tube	Part number
1/8"	M20200100
5/32"	M20200200
1/4"	M20200400

## Stem Expander (stem/tube)



O/D tube	Part number
1/8" to 1/4"	C20230104
5/32" to 1/4"	C20230204

## Union Elbow



O/D tube	Part number
1/8"	M20400100
5/32"	M20400200
1/4"	M20400400

## Union Tee



O/D tube	Part number
1/8"	M20600100
5/32"	M20600200
1/4"	M20600400

## Banjo Flow Control



O/D tube	Thread	Part number
1/8"	10-32 UNF	C2VA00110 regulating out
1/8"	10-32 UNF	C2WA00110 regulating out

# Pneufit C push-in fittings

Inch

Ø 1/8" to 1/2" O/D tube

Pneufit® C Manifolds



## Male Manifold

Tube	Thread	Part number
1/4"-5/32"	1/8" NPT	C24D30218
5/16"-5/32"	1/4" NPT	C24D30228
5/16"-3/16"	1/4" NPT	C24D30328
5/16"-1/4"	1/4" NPT	C24D30428
3/8"-1/4"	3/8" NPT	C24D30438



## Manifold Union

Tube	Part number
3/16"-5/32"	C20D30302
1/4"- 5/32"	C20D30402
5/16"- 5/32"	C20D30502
5/16"-3/16"	C20D30503
5/16"-1/4"	C20D30504
3/8"- 1/4"	C20D30604
3/8"- 5/16"	C20D30605



## Stem Manifold

Tube	Part number
3/16"- 5/32"	C20J30302
1/4"- 5/32"	C20J30402
5/16"-5/32"	C20J30502
5/16"-3/16"	C20J30503
5/16"-1/4"	C20J30504
3/8"- 1/4"	C20J30604
3/8"-5/16"	C20J30605

3/2 Shut off valves



## Thread to thread

NPT thread to thread	Part number
1/8"	C24GG1818
1/4"	C24GG2828
3/8"	C24GG3838
1/2"	C24GG4848



## Tube to tube

Tube to tube	Part number
1/4"	C20GF0400
5/16"	C20GF0500
3/8"	C20GF0600
1/2"	C20GF0700



## Tube to thread

Inlet tube O/D	Outlet NPT thread	Part number
1/4"	1/8"	C24GH 0418
1/4"	1/4"	C24GH 0428
1/4"	3/8"	C24GH 0438
5/16"	1/8"	C24GH 0518
5/16"	1/4"	C24GH 0528
5/16"	3/8"	C24GH 0538
3/8"	1/4"	C24GH 0628
3/8"	3/8"	C24GH 0638
3/8"	1/2"	C24GH 0648
1/2"	3/8"	C24GH 0738
1/2"	1/2"	C24GH 0748



## Thread to tube

Inlet NPT thread	Outlet tube O/D	Part number
1/8"	1/4"	C24GJ 0418
1/8"	5/16"	C24GJ 0518
1/4"	1/4"	C24GJ 0428
1/4"	5/16"	C24GJ 0528
1/4"	3/8"	C24GJ 0628
3/8"	1/4"	C24GJ 0438
3/8"	5/16"	C24GJ 0538
3/8"	3/8"	C24GJ 0638
1/2"	3/8"	C24GJ 0648
1/2"	1/2"	C24GJ 0748