

Pneufit® C composite and Pneufit M fittings

Metric

Ø 3 to 16 mm O/D tube

Releasable stainless-steel grab-ring to grip nylon or polyurethane tube (85 or 95 durometer).

Nickel plated brass components. Pre-applied thread sealant on all taper threads and recessed captive O-ring on parallel threads. Internal and external hexagons on straight fittings. Immediate quality sealing using silicone free U-packing.

Technical data

Medium

Compressed air

Operating pressure

750mm Hg vacuum, up to 10 bar

Temperature

0 to 60°C

Medium

compressed air

Tube sizes

Standard sizes:

4, 6, 8, 10, 12, 16 mm

Miniature sizes:

3, 4, and 6 mm

Thread sizes

Standard sizes:

M5, M6, 1/8, 1/4, 3/8 and 1/2 inch

ISO G and ISO R

Miniature sizes:

M3, M5 and 1/8 inch ISO R

Tube types

Nylon 11 or 12

Polyurethane 85, 95 or 98 durometer

Materials

Body: PBT

Seals: NBR (silicone free) u-packing and O-rings

Threaded bodies: nickel plated brass

Release sleeve and backing ring: POM

Grab-ring: stainless steel

Collar: nickel plated brass

Thread sealant: threebond 2350B



- 1 Impact resistant PBT body in black for Pneufit® C and light gray for Pneufit® M.
- 2 Release buttons are red for metric, grey for inch, and light grey oval for Pneufit® M.
- 3 Stainless steel grab ring with special design to retain softer tube and provide easy releasability.
- 4 Silicon free U-packing provides leak tight tube seal under side loading.
- 5 Stem seal provides leak tight 360° swivel connection.
- 6 Nickel plated brass threads and notches on hex to signify NPT.
- 7 Pre-applied thread sealant on tapered threads and recessed captive O-ring on parallel threads.

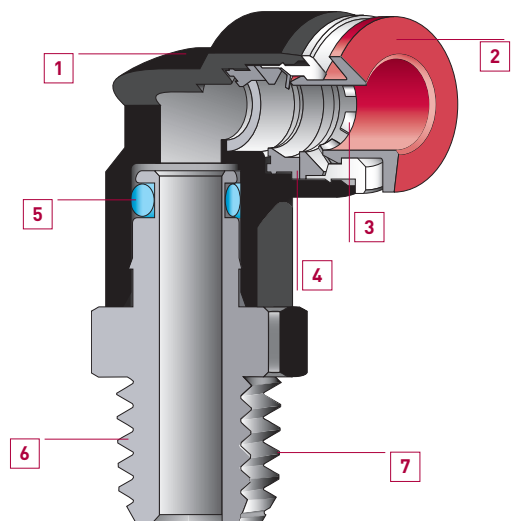

Method of assembly

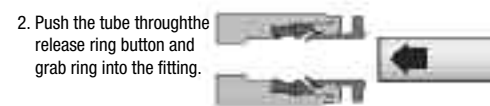
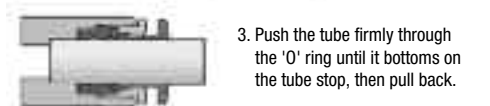
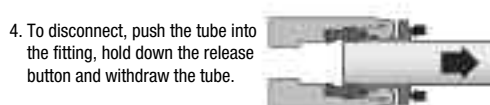
1. Ensure that the end tube is cut square and is free from burrs. 
2. Push the tube through the release ring button and grab ring into the fitting. 
3. Push the tube firmly through the 'O' ring until it bottoms on the tube stop, then pull back. 
4. To disconnect, push the tube into the fitting, hold down the release button and withdraw the tube. 

Pneufit® C composite and Pneufit M fittings

Metric

Ø 3 to 16 mm O/D tube

Straight adapter (external + internal hex)



O/D tube	Thread	Part number
4mm	M5	C02250405
4mm	M6	C02250406
4mm	1/8" R	C01250418
4mm	1/4" R	C01250428
4mm	3/8" R	C01250438
4mm	1/8" G	C02250418
4mm	1/4" G	C02250428
4mm	3/8" G	C02250438
6mm	M5	C02250605
6mm	M6	C02250606
6mm	1/8" R	C01250618
6mm	1/4" R	C01250628
6mm	3/8" R	C01250638
6mm	1/2" R	C01250648
6mm	1/8" G	C02250618
6mm	1/4" G	C02250628
6mm	3/8" G	C02250638
8mm	1/8" R	C01250818
8mm	1/4" R	C01250828
8mm	3/8" R	C01250838
8mm	1/2" R	C01250848
8mm	1/8" G	C02250818
8mm	1/4" G	C02250828
8mm	3/8" G	C02250838
8mm	1/2" G	C02250848
10mm	1/8" R	C01251018
10mm	1/4" R	C01251028
10mm	3/8" R	C01251038
10mm	1/2" R	C01251048
10mm	1/8" G	C02251018
10mm	1/4" G	C02251028
10mm	3/8" G	C02251038
10mm	1/2" G	C02251048
12mm	1/8" R	C01251218
12mm	1/4" R	C01251228
12mm	3/8" R	C01251238
12mm	1/2" R	C01251248
12mm	1/4" G	C02251228
12mm	3/8" G	C02251238
12mm	1/2" G	C02251248
16mm	3/8" R	C01251638
16mm	1/2" R	C01251648
16mm	3/8" G	C02251638
16mm	1/2" G	C02251648



Straight adapter (internal hex only)

O/D tube	Thread	Part number
4mm	M5	C022A0405
4mm	M6	C022A0406
4mm	1/8" R	C012A0418
4mm	1/4" R	C012A0428
4mm	3/8" R	C012A0438
6mm	M5	C022A0605
6mm	M6	C022A0606
6mm	1/8" R	C012A0618
6mm	1/4" R	C012A0628
6mm	3/8" R	C012A0638
8mm	1/8" R	C012A0818
8mm	1/4" R	C012A0828
8mm	3/8" R	C012A0838
8mm	1/2" R	C012A0848
10mm	1/8" R	C012A1018
10mm	1/4" R	C012A1028
10mm	3/8" R	C012A1038
10mm	1/2" R	C012A1048
12mm	1/8" R	C012A1218
12mm	1/4" R	C012A1228
12mm	3/8" R	C012A1238
12mm	1/2" R	C012A1248



Straight adapter (female thread)

O/D tube	Thread	Part number
4mm	M5	C02260405
4mm	1/8" G	C02260418
4mm	1/4" G	C02260428
4mm	3/8" G	C02260438
6mm	1/8" G	C02260618
6mm	1/4" G	C02260628
6mm	3/8" G	C02260638
8mm	1/8" G	C02260818
8mm	1/4" G	C02260828
8mm	3/8" G	C02260838
8mm	1/2" G	C02260848
10mm	1/8" G	C02261018
10mm	1/4" G	C02261028
10mm	3/8" G	C02261038
10mm	1/2" G	C02261048
12mm	1/4" G	C02251228
12mm	3/8" G	C02261238
12mm	1/2" G	C02261248

Pneufit® C composite and Pneufit M fittings

Metric

Ø 3 to 16 mm O/D tube



Straight Adaptor (female bulkhead)

O/D tube	Thread	Part number
4mm	1/8" G	C02320418
4mm	1/4" G	C02320428
4mm	3/8" G	C02320438
6mm	1/8" G	C02320618
6mm	1/4" G	C02320628
6mm	3/8" G	C02320638
8mm	1/8" G	C02320818
8mm	1/4" G	C02320828
8mm	3/8" G	C02320838
10mm	1/4" G	C02321028
10mm	3/8" G	C02321038
10mm	1/2" G	C02321048
12mm	1/4" G	C02321228
12mm	3/8" G	C02321238
12mm	1/2" G	C02321248



90° Swivel elbow adapter (extended)

O/D tube	Thread	Part number
4mm	M5	C02540405
4mm	M6	C02540406
4mm	1/8" R	C01540418
4mm	1/4" R	C01540428
4mm	3/8" R	C01540438
6mm	M5	C02540605
6mm	M6	C02540606
6mm	1/8" R	C01540618
6mm	1/4" R	C01540628
6mm	3/8" R	C01540638
6mm	1/2" R	C01540648
8mm	1/8" R	C01540818
8mm	1/4" R	C01540828
8mm	3/8" R	C01540838
8mm	1/2" R	C01540848
10mm	1/8" R	C01541018
10mm	1/4" R	C01541028
10mm	3/8" R	C01541038
10mm	1/2" R	C01541048
12mm	1/8" R	C01541218
12mm	1/4" R	C01541228
12mm	3/8" R	C01541238
12mm	1/2" R	C01541248
16mm	3/8" R	C01541638
16mm	1/2" R	C01541648

90° Swivel elbow



O/D tube	Thread	Part number
4mm	M5	C02470405
4mm	M6	C02470406
4mm	1/8" R	C01470418
4mm	1/4" R	C01470428
4mm	3/8" R	C01470438
4mm	1/8" G	C02470418
4mm	1/4" G	C02470428
4mm	3/8" G	C02470438
6mm	M5	C02470605
6mm	M6	C02470606
6mm	1/8" R	C02470618
6mm	1/4" G	C02470628
6mm	3/8" G	C02470638
8mm	1/8" R	C01470818
8mm	1/4" R	C01470828
8mm	3/8" R	C01470838
8mm	1/2" R	C01470848
8mm	1/8" G	C02470818
8mm	1/4" G	C02470828
8mm	3/8" G	C02470838
8mm	1/2" G	C02470848
10mm	1/8" R	C01471018
10mm	1/4" R	C01471028
10mm	3/8" R	C01471038
10mm	1/2" R	C01471048
10mm	1/8" G	C02471018
10mm	1/4" G	C02471028
10mm	3/8" G	C02471038
10mm	1/2" G	C02471048
12mm	1/8" R	C01471218
12mm	1/4" R	C01471228
12mm	3/8" R	C01471238
12mm	1/2" R	C01471248
12mm	1/4" G	C02471228
12mm	3/8" G	C02471238
12mm	1/2" G	C02471248
16mm	3/8" R	C01471638
16mm	1/2" R	C01471648
16mm	3/8" G	C02471638
16mm	1/2" G	C02471648



90° Swivel elbow adapter (female)

O/D tube	Thread	Part number
4mm	M5	C02480405
4mm	M6	C02480406
4mm	1/8" R	C01480418
4mm	1/4" R	C01480428
6mm	M5	C02480605
6mm	M6	C02480606
6mm	1/8" R	C01480618
6mm	1/4" R	C01480628
6mm	3/8" R	C01480638
8mm	1/8" R	C01480818
8mm	1/4" R	C01480828
8mm	3/8" R	C01480838
10mm	1/4" R	C01481028
10mm	3/8" R	C01481038
10mm	1/2" R	C01481048
12mm	1/4" R	C01481228
12mm	3/8" R	C01481238
12mm	1/2" R	C01481248

Pneufit® C composite and Pneufit M fittings

Metric

Ø 3 ... 16 mm O/D tube

Swivel Y adapter



O/D tube	Thread	Part number
4mm	M5	C02880405
4mm	M6	C02880406
4mm	1/8" R	C01880418
4mm	1/4" R	C01880428
4mm	3/8" R	C01880438
4mm	1/8" G	C02880418
4mm	1/4" G	C02880428
4mm	3/8" G	C02880438
6mm	M5	C02880605
6mm	M6	C02880606
6mm	1/8" R	C01880618
6mm	1/4" R	C01880628
6mm	3/8" R	C01880638
6mm	1/2" R	C01880648
6mm	1/8" G	C02880618
6mm	1/4" G	C02880628
6mm	3/8" G	C02880638
6mm	1/2" G	C02880648
8mm	1/8" R	C01880818
8mm	1/4" R	C01880828
8mm	3/8" R	C01880838
8mm	1/2" R	C01880848
8mm	1/8" G	C02880818
8mm	1/4" G	C02880828
8mm	3/8" G	C02880838
8mm	1/2" G	C02880848
10mm	1/8" R	C01881018
10mm	1/4" R	C01881028
10mm	3/8" R	C01881038
10mm	1/2" R	C01881048
10mm	1/8" G	C02881018
10mm	1/4" G	C02881028
10mm	3/8" G	C02881038
10mm	1/2" G	C02881048
12mm	1/8" R	C01881218
12mm	1/4" R	C01881228
12mm	3/8" R	C01881238
12mm	1/2" R	C01881248
12mm	1/4" G	C02881228
12mm	3/8" G	C02881238
12mm	1/2" G	C02881248



Swivel tee adapter

O/D tube	Thread	Part number
4mm	M5	C02670405
4mm	M6	C02670406
4mm	1/8" R	C01670418
4mm	1/4" R	C01670428
4mm	3/8" R	C01670438
4mm	1/8" G	C02670418
4mm	1/4" G	C02670428
4mm	3/8" G	C02670438
6mm	M5	C02670605
6mm	M6	C02670606
6mm	1/8" R	C01670618
6mm	1/4" R	C01670628
6mm	3/8" R	C01670638
6mm	1/2" R	C01670648
6mm	1/8" G	C02670618
6mm	1/4" G	C02670628
6mm	3/8" G	C02670638
6mm	1/2" G	C02670648
8mm	1/8" R	C01670818
8mm	1/4" R	C01670828
8mm	3/8" R	C01670838
8mm	1/2" R	C01670848
8mm	1/8" G	C02670818
8mm	1/4" G	C02670828
8mm	3/8" G	C02670838
8mm	1/2" G	C02670848
10mm	1/8" R	C01671018
10mm	1/4" R	C01671028
10mm	3/8" R	C01671038
10mm	1/2" R	C01671048
10mm	1/8" G	C02671018
10mm	1/4" G	C02671028
10mm	3/8" G	C02671038
10mm	1/2" G	C02671048
12mm	1/8" R	C01671218
12mm	1/4" R	C01671228
12mm	3/8" R	C01671238
12mm	1/2" R	C01671248
12mm	1/4" G	C02671228
12mm	3/8" G	C02671238
12mm	1/2" G	C02671248
16mm	3/8" R	C01671638
16mm	1/2" R	C01671648
16mm	3/8" G	C02671638
16mm	3/8" G	C02671638

Pneufit® C composite and Pneufit M fittings

Metric

Ø 3 to 16 mm O/D tube

Swivel side tee adapter



O/D tube	Thread	Part number
4mm	M5	C02680405
4mm	M6	C02680406
4mm	1/8" R	C01680418
4mm	1/4" R	C01680428
4mm	3/8" R	C01680438
4mm	1/8" G	C02680418
4mm	1/4" G	C02680428
4mm	3/8" G	C02680438
6mm	M5	C02680605
6mm	M6	C02680606
6mm	1/8" R	C02680618
6mm	1/4" R	C01680628
6mm	3/8" R	C01680638
6mm	1/2" R	C01680648
6mm	1/8" G	C02680618
6mm	1/4" G	C02680628
6mm	3/8" G	C02680638
8mm	1/8" R	C01680818
8mm	1/4" R	C01680828
8mm	3/8" R	C01680838
8mm	1/2" R	C01680848
8mm	1/8" G	C02680818
8mm	1/4" G	C02680828
8mm	3/8" G	C02680838
8mm	1/2" G	C02680848
10mm	1/8" R	C01681018
10mm	1/4" R	C01681028
10mm	3/8" R	C01681038
10mm	1/2" R	C01681048
10mm	1/8" G	C02681018
10mm	1/4" G	C02681028
10mm	3/8" G	C02681038
10mm	1/2" G	C02681048
12mm	1/8" R	C01681218
12mm	1/4" R	C01681228
12mm	3/8" R	C01681238
12mm	1/2" R	C01681248
12mm	1/4" G	C02681228
12mm	3/8" G	C02681238
12mm	1/2" G	C02681248



Swivel tee adapter

O/D tube	Thread	Part number
4mm	M5	C026C0405
4mm	M6	C026C0406
4mm	1/8" R	C016C0418
4mm	1/4" R	C016C0428
6mm	M5	C026C0605
6mm	M6	C026C0606
6mm	1/8" R	C016C0628
6mm	1/4" R	C016C0628
6mm	3/8" R	C016C0638
8mm	1/8" R	C016C0818
8mm	1/4" R	C016C0828
8mm	3/8" R	C016C0838
8mm	1/2" R	C016C0848
10mm	1/8" R	C016C1018
10mm	1/4" R	C016C1028
10mm	3/8" R	C016C1038
10mm	1/2" R	C016C1048
12mm	1/4" R	C016C1228
12mm	3/8" R	C016C1238
12mm	1/2" R	C016C1248

Banjo



O/D tube	Thread	Part number
4mm	M5	COA510405
4mm	M6	COA510406
4mm	1/8" G	COA510418
4mm	1/4" G	COA510428
6mm	M5	COA510605
6mm	1/8" G	COA510618
6mm	1/4" G	COA510628
6mm	3/8" G	COA510638
8mm	1/8" G	COA510818
8mm	1/4" G	COA510828
8mm	3/8" G	COA510838
8mm	1/2" G	COA510848
10mm	1/4" G	COA511028
10mm	3/8" G	COA511038
10mm	1/2" G	COA511048
12mm	3/8" G	COA511238
12mm	1/2" G	COA511248

Banjo with top port



O/D tube	Thread	Part number
4mm	M5	COD510405
4mm	1/8" R	COE510418
4mm	1/4" R	COF510428
6mm	M5	COD510605
6mm	1/8" R	COE510618
6mm	1/4" R	COF510628
6mm	3/8" R	COG510638
8mm	1/8" R	COE510818
8mm	1/4" R	COF510828
8mm	3/8" R	COG510838
10mm	1/4" R	COF511028
10mm	3/8" R	COG511038
12mm	3/8" R	COG511238

Pneufit® C composite and Pneufit M fittings

Metric

Ø 3 to 16 mm O/D tube

Banjo flow control (regulating out)



O/D tube	Thread	Part number
4mm	M5	COK510405
4mm	1/8" R	COTA00418
4mm	1/4" R	COTA00428
4mm	1/8" G	COK510418
4mm	1/4" G	COK510428
6mm	M5	COK510605
6mm	1/8" R	COTA00618
6mm	1/4" R	COTA00628
6mm	3/8" R	COTA00638
6mm	1/8" G	COK510618
6mm	1/4" G	COK510628
6mm	3/8" G	COK510638
8mm	1/8" R	COTA00818
8mm	1/4" R	COTA00828
8mm	3/8" R	COTA00838
8mm	1/2" R	COTA00848
8mm	1/8" G	COK510818
8mm	1/4" G	COK510828
8mm	3/8" G	COK510838
10mm	1/4" R	COTA01028
10mm	3/8" R	COTA01038
10mm	1/2" R	COTA01048
10mm	1/4" G	COK511028
10mm	3/8" G	COK511038
10mm	1/2" G	COK511048
12mm	1/4" R	COTA01228
12mm	3/8" R	COTA01238
12mm	1/2" R	COTA01248
12mm	1/4" G	COK511228
12mm	3/8" G	COK511238
12mm	1/2" G	COK511248

Bulkhead union



O/D tube	Part number
4mm	C00290400
6mm	C00290600
8mm	C00290800
10mm	C00291000
12mm	C00291200

Stem union



O/D tube	Part number
4mm	C00220400
6mm	C00220600
8mm	C00220800
10mm	C00221000
12mm	C00221200
16mm	C00221600

Plug



O/D tube	Part number
4mm	C00040400
6mm	C00040600
8mm	C00040800
10mm	C00041000
12mm	C00041200
16mm	C00041600

In line flow control



O/D tube	Part number
4mm	C00GE0400
6mm	C00GE0600
8mm	C00GE0800
10mm	C00GE1000
12mm	C00GE1200

Cap

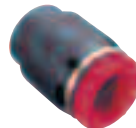

O/D tube	Part number
4mm	C00120400
6mm	C00120600
8mm	C00120800
10mm	C00121000
12mm	C00121200
16mm	C00121600

Straight union



O/D tube	Part number
4mm	C00200400
6mm	C00200600
8mm	C00200800
10mm	C00201000
12mm	C00201200
16mm	C00201600

Union elbow

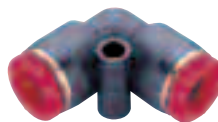

O/D tube	Part number
4mm	C00400400
6mm	C00400600
8mm	C00400800
10mm	C00401000
12mm	C00401200
16mm	C00401600

Pneufit® C composite and Pneufit M fittings

Metric

Ø 3 to 16 mm O/D tube



Stem elbow

O/D tube	Part number
4mm	C00430400
6mm	C00430600
8mm	C00430800
10mm	C00431000
12mm	C00431200
16mm	C00431600



Union Y

O/D tube	Part number
4mm	C00820400
6mm	C00820600
8mm	C00820800
10mm	C00821000
12mm	C00821200



Union tee

O/D tube	Part number
4mm	C00600400
6mm	C00600600
8mm	C00600800
10mm	C00601000
12mm	C00601200
16mm	C00601600



Stem Y

O/D tube	Part number
4mm	C00840400
6mm	C00840600
8mm	C00840800
10mm	C00841000
12mm	C00841200



Stem tee

O/D tube	Part number
4mm	C00630400
6mm	C00630600
8mm	C00630800
10mm	C00631000
12mm	C00631200



Union cross

O/D tube	Part number
4mm	C00900400
6mm	C00900600
8mm	C00900800
10mm	C00901000
12mm	C00901200



Stem side tee

O/D tube	Part number
4mm	C00640400
6mm	C00640600
8mm	C00640800
10mm	C00641000
12mm	C00641200



Straight union (unequal)

O/D tube	Part number
6 - 4mm	C00200604
8 - 6mm	C00200806
10 - 8mm	C00201008
12 - 10mm	C00201210
16 - 12mm	C00201612

Pneufit® C composite and Pneufit M fittings

Metric

Ø 3 to 16 mm O/D tube

Stem Reducer (stem/tube)



O/D tube	Part number
6 - 4mm	C00230604
8 - 4mm	C00230804
8 - 6mm	C00230806
10 - 6mm	C00231006
10 - 8mm	C00231008
12 - 8mm	C00231208
12 - 10mm	C00231210
16 - 12mm	C00231612

Stem Side Tee (unequal)



O/D tube	Part number
6 - 4mm	C00640604
8 - 6mm	C00640806
10 - 8mm	C00641008
12 - 10mm	C00641210

Stem Expander (stem/tube)

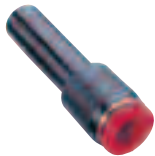

O/D tube	Part number
6 - 4mm	C00230406
8 - 4mm	C20220402
8 - 6mm	C00230608
10 - 6mm	C20220504
10 - 8mm	C20220604
12 - 8mm	C20220605
16 - 12mm	C20220706

Stem Tee (unequal)



O/D tube	Part number
6 - 4mm	C00630604
8 - 6mm	C00630806
10 - 8mm	C00631008
12 - 10mm	C00631210

Stem Union (unequal)



O/D tube	Part number
6 - 4mm	C00220604
8 - 6mm	C00220806
10 - 8mm	C00221008
12 - 10mm	C00221210
16 - 12mm	C00221612

Union Y (unequal)

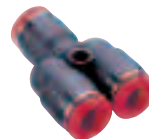

O/D tube	Part number
6 - 4mm	C00820604
8 - 6mm	C00820806
10 - 8mm	C00821008
12 - 10mm	C00821210

Union Tee (unequal)

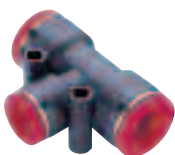

O/D tube	Part number
6 - 4mm	C006A0604
8 - 6mm	C006A0806
10 - 6mm	C006A1006
10 - 8mm	C006A1008
12 - 8mm	C006A1208
12 - 10mm	C006A1210
16 - 12mm	C006A1612

Stem Y (unequal)

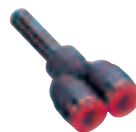

O/D tube	Part number
6 - 4mm	C00840604
8 - 6mm	C00840806
10 - 8mm	C00841008
12 - 10mm	C00841210

Pneufit® C composite and Pneufit M fittings

Metric

Ø 3 to 16 mm O/D tube

MINIATURE PNEUFIT® M



Straight adapter (external + internal hex)

O/D tube	Thread	Part number
3mm	M3	M02250303
3mm	M5	M02250305
3mm	M6	M02250306
4mm	M3	M02250403
4mm	M5	M02250405
4mm	M6	M02250406
4mm	1/8"	M01250418
6mm	M5	M02250605
6mm	M6	M02250606
6mm	1/8"	M01250618



90° Swivel Elbow Adapter

O/D tube	Thread	Part number
3mm	M3	M02470303
3mm	M5	M02470305
3mm	M6	M02470306
4mm	M3	M02470403
4mm	M5	M02470405
4mm	M6	M02470406
4mm	1/8"	M01470418
6mm	M5	M02470605
6mm	M6	M02470606
6mm	1/8"	M01470618



Straight adapter (internal hex only)

O/D tube	Thread	Part number
3mm	M3	M022A0303
3mm	M5	M022A0305
3mm	M6	M022A0306
4mm	M3	M022A0403
4mm	M5	M022A0405
4mm	M6	M022A0406
4mm	1/8"	M012A0418
6mm	M5	M022A0605
6mm	M6	M022A0606
6mm	1/8"	M012A0618



Swivel Tee Adapter

O/D tube	Thread	Part number
3mm	M3	M02670303
3mm	M5	M02670305
3mm	M6	M02670306
4mm	M3	M02670403
4mm	M5	M02670405
4mm	M6	M02670406
4mm	1/8"	M01670418
6mm	M5	M02670605
6mm	M6	M02670606
6mm	1/8"	M01670618



Straight adapter (female thread)

O/D tube	Thread	Part number
3mm	M3	M02260303
3mm	M5	M02260305
3mm	M6	M02260306
4mm	M3	M02260403
4mm	M5	M02260405
4mm	M6	M02260406
4mm	1/8"	M01260418
6mm	M6	M02260606
6mm	1/8"	M01260618



Swivel Side Tee Adapter

O/D tube	Thread	Part number
3mm	M3	M02680303
3mm	M5	M02680305
3mm	M6	M02680306
4mm	M3	M02680403
4mm	M5	M02680405
4mm	M6	M02680406
4mm	1/8"	M01680418
6mm	M5	M02680605
6mm	M6	M02680606
6mm	1/8"	M01680618

Pneufit® C composite and Pneufit M fittings

Metric

Ø 3 to 16 mm O/D tube



Straight Union

O/D tube	Part number
3mm	M00200300
4mm	M00200400
6mm	M00200600



Straight Union (unequal)

O/D tube	Part number
3mm	M00200403
4mm	M00200603
6mm	M00200604



Union Elbow

O/D tube	Part number
3mm	M00400300
4mm	M00400400
6mm	M00400600



Stem Reducer (stem/tube)

O/D tube	Thread	Part number
3mm	M5	C0K510305
4mm	M5	C0K510405
6mm	M5	C0K510605



Union Tee

O/D tube	Part number
3mm	M00600300
4mm	M00600400
6mm	M00600600

Pneufit® C composite and Pneufit M fittings

Metric

Ø 3 to 16 mm O/D tube

3/2 Shut off valves

PNEUFIT® C MANIFOLDS



Male Manifold

O/D tube	Thread	Part number
6 - 4mm	1/8" R	C01D30418
8 - 4mm	1/4" R	C01D30428
8 - 6mm	1/4" R	C01D30628
10 - 8mm	3/8" R	C01D30838



Manifold Union

O/D tube	Part number
6 - 4mm	C00D30604
8 - 4mm	C00D30804
8 - 6mm	C00D30806
10 - 6mm	C00D31006
10 - 8mm	C00D31008



Stem Manifold

O/D tube	Part number
6 - 4mm	C00J30604
8 - 4mm	C00J30804
8 - 6mm	C00J30806
10 - 8mm	C00J31008

Thread to thread

ISO R thread to thread	Part number
R 1/8"	C01GG1818
R 1/4"	C01GG2828
R 3/8"	C01GG3838
R 1/2"	C01GG4848



Tube to tube

Tube to tube (mm)	Part number
6	C00GF0600
8	C00GF0800
10	C00GF1000
12	C00GF1200



Tube to thread

Inlet tube O/D (mm)	Outlet ISO R thread	Part number
6	R 1/8	C01GH 0618
6	R 1/4	C01GH 0628
6	R 3/8	C01GH 0638
8	R 1/8	C01GH 0818
8	R 1/4	C01GH 0828
8	R 3/8	C01GH 0838
10	R 1/4	C01GH 1028
10	R 3/8	C01GH 1038
10	R 1/2	C01GH 1048
12	R 1/4	C01GH 1228
12	R 3/8	C01GH 1238
12	R 1/2	C01GH 1248



Thread to tube

Inlet ISO R thread	Outlet tube O/D (mm)	Part number
R 1/8	6	C01GJ 0618
R 1/8	8	C01GJ 0818
R 1/4	6	C01GJ 0628
R 1/4	8	C01GJ 0828
R 1/4	10	C01GJ 1028
R 1/4	12	C01GJ 1228
R 3/8	6	C01GJ 0638
R 3/8	8	C01GJ 0838
R 3/8	10	C01GJ 1038
R 3/8	12	C01GJ 1238
R 1/2	10	C01GJ 1048
R 1/2"	12	C01GJ 1248

